



# LEANLOADER

ROBOT EXPERTS WHO UNDERSTAND  
MACHINE TOOLS



# PRODUCT FEATURES

## APPLICATION FEATURES



### Application Industry

- Power tools industry
- Pneumatic / hydraulic / pipeline components industry
- Motor, high voltage electrical industry

### Processing Technology

- Lathe
- CNC Machining Center
- Drilling and tapping
- Grinding

### Applicable Workpieces

- Small- and medium-sized workpieces, round bars
- Angular workpieces
- Height less than 95mm

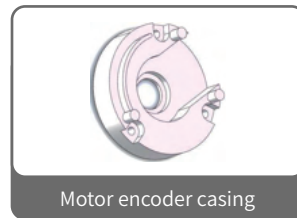

## TYPES OF CNC TENDING



One Robot to One CNC Machine

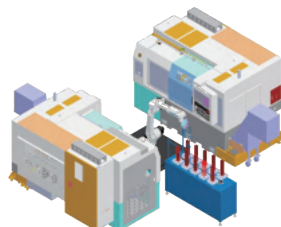

One Robot to Two CNC Machine

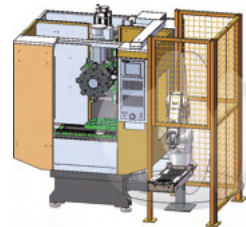

CNC Milling Machine Tending from Front or Side



## ELECTRICAL CONTROL SYSTEM

### LXC-917Y/1206R

- Integrate robot controller and peripheral devices
- Space saving      ■ Hardware cost saving
- Simplify electrical design



### LXC-1468C

- Independent robot electric control cabinet



## PRODUCT BENEFITS



Easy Installation

Easy Debugging

Easy Connection

Quick Line Change

Non-stop production

Time Consumption	Model Change	Product Change
LeanLoader	30 min(s)	10 min(s)
Conventional Robots	>24 hours	>24 hours

## EXTENSION OF APPLICATION MODULE

### Arm Safety Zone



- Setting a safety protection area can prevent the robot from entering a specific area.

### Tray Module



- Parameterizing the matrix tray eliminates the need to repeat teaching points.
- Various teaching modes to meet application requirements.

### Vision Alignment Module

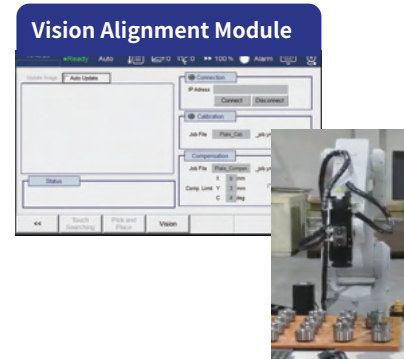

- Integration of vision functions
- Compatibility with commercially available cameras
- QR code recognition
- Machine tool/tray position calibration

### Collision Detection

#### Torque limit off



#### Torque limit on

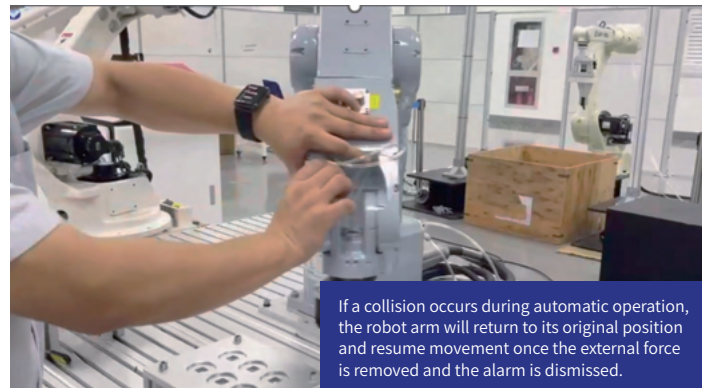
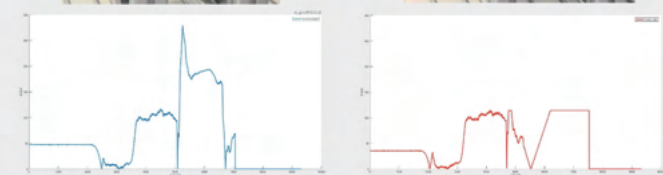

If a collision occurs during automatic operation, the robot arm will return to its original position and resume movement once the external force is removed and the alarm is dismissed.

- Record regular axis loading in learning mode.
- Protect against unexpected impacts during robot movement.

## CENTRAL CONTROL

- Central control is a platform or software used to manage robotic units in a processing site.
- It allows users to obtain information about the equipment.
- Users can determine how each piece of equipment should be used based on the current situation.
- With this software, users can easily monitor and control the equipment as needed.

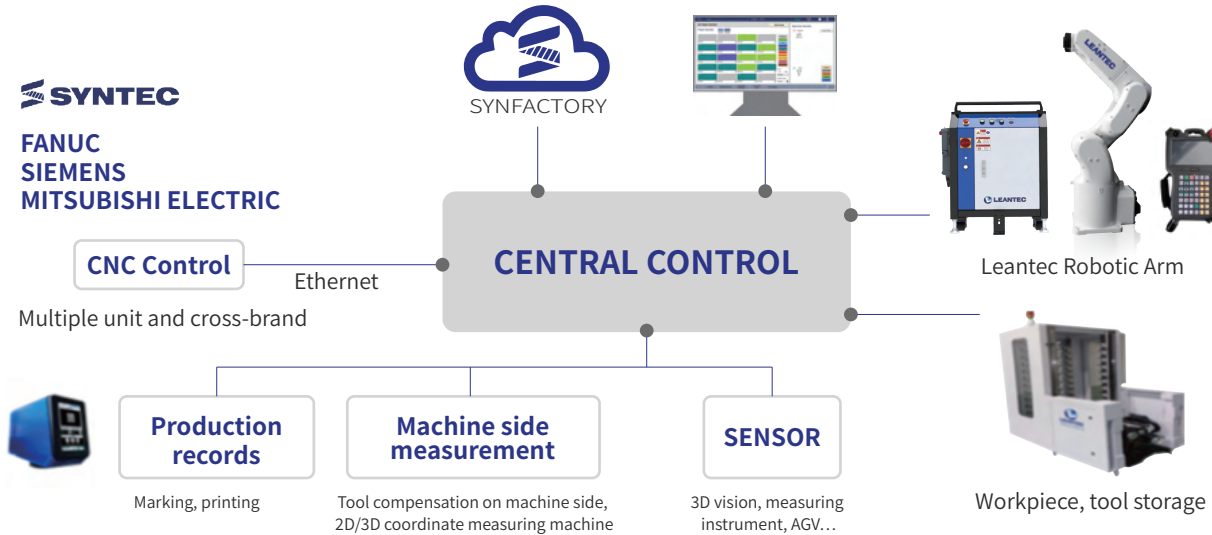

## PRODUCT BENEFITS

### CONVENTIONAL PRODUCTION VS LEANLOADER

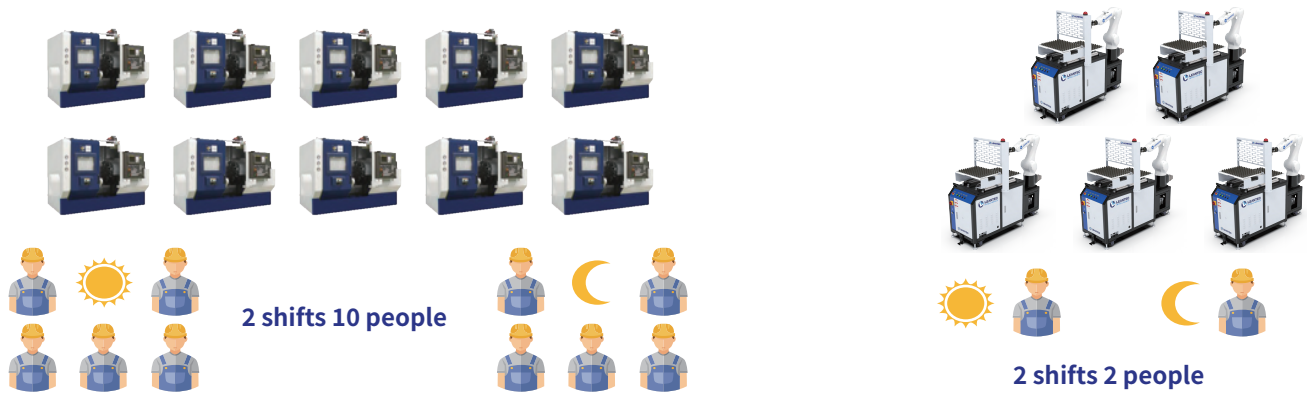

### CONVENTIONAL PRODUCTION VS LEANLOADER COST EXPENDITURE

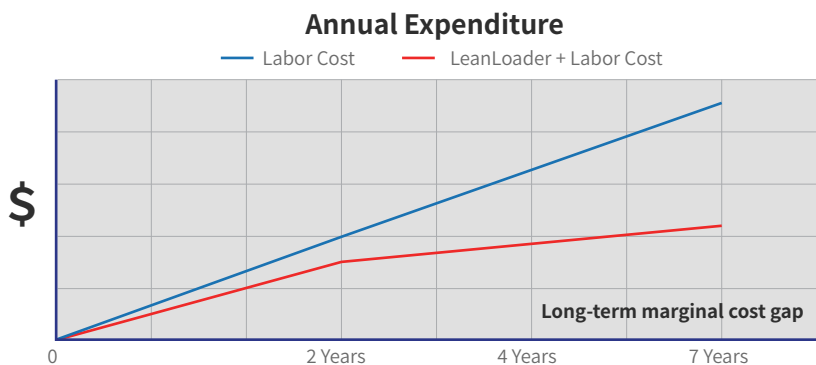

Labor cost savings– For example: 10 CNCs

**ROI** About 2 years

Cost-Saving Labor Efficiency  
**Boosting output!!!**

# PRODUCT SPECIFICATIONS

The LeanLoader can be equipped with Leantec Y series 917 arm, R series 1206 arm, C series 1468 arm and other robot products.



SPECIFICATION			
<b>Product Model</b>	LXC100-917Y	LXC100-1206R	LXC11P-1468C
<b>Robot Model</b>	LA917-6-Y	LA1206-10-R	LA1468-10-C
<b>Robot Payload (kg)</b>	6	10	10
<b>Robot Arm Reach (mm)</b>	917	1206	1468
<b>Robot Repeatability (mm)</b>	±0.03	±0.05	±0.08
<b>Tray Size (mm)</b>	570x420	570x420	1000x600
<b>Tray Maximum Load (kg)</b>	60	60	60
<b>IP Rating</b>	IP54	IP54	IP54
<b>End-Effector</b>	Optional	Optional	Optional
<b>Product Dimension (mm) A x B x C</b>	1700x600x1550	1700x600x1550	2500x1100x1550

## APPLICATION FEATURES

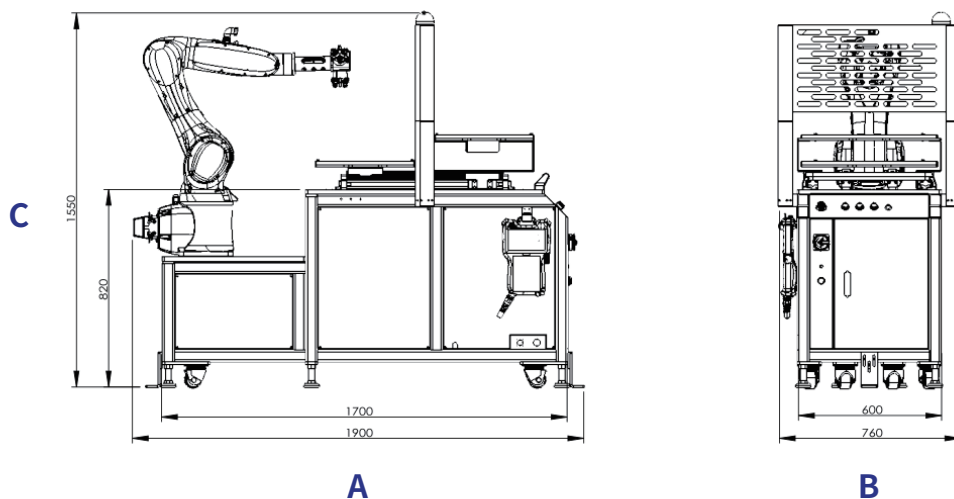



ROBOT EXPERTS WHO UNDERSTAND MACHINE TOOLS